

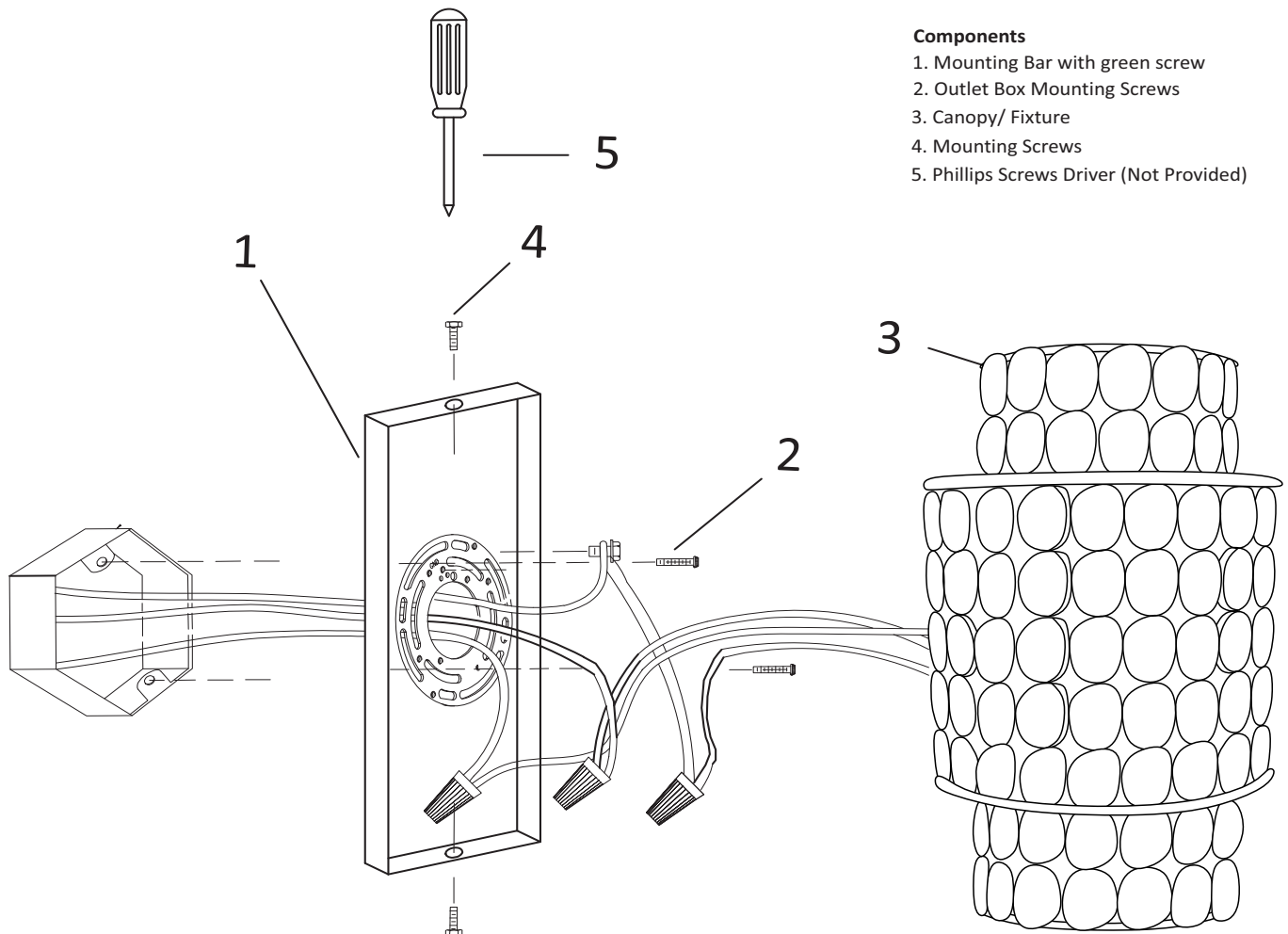

ASSEMBLY AND INSTALLATION INSTRUCTIONS for the 654121 Fixture

Important Safety information (Please read before proceeding)

1. Remove the fixture, parts and all mounting hardware bags (orange) from the carton and verify that all parts are present according to the illustration sheet. All parts must be used as indicated. Do not replace any parts, leave any parts out, or use any parts which are worn out or broken. Failure to follow the instructions could cause a hazardous situation, voids the warranty and violates the U.L. listing of the fixture.
2. To prevent the electric shock, turn off the main power at the circuit breaker before installing the fixture. NEVER attempt to install, clean or replace bulbs without shutting off the electricity to the fixture.
3. Never use light bulbs with wattage ratings that exceed the fixtures maximum rating. Always make sure the electric current is turned off before changing the bulbs.
4. If you experience difficulties installing the lighting fixture or it fails to work as expected, please contact a local qualified licensed electrical contractor.
5. Please contact your local Capital Lighting Fixture reseller with any assembly or installation questions. Your local reseller can also provide you with replacement parts for your new fixture.



Components

1. Mounting Bar with green screw
2. Outlet Box Mounting Screws
3. Canopy/ Fixture
4. Mounting Screws
5. Phillips Screws Driver (Not Provided)

Assembly Instructions for the 654121 fixture

1. Attach Mounting Bar (1) to Outlet Box with Outlet Box Mounting Screws (2). Mounting Bar (1) must be positioned with extruded thread faced into Outlet Box.
2. Connect fixture ground wire to outlet box ground wire with wire connector supplied; connect white fixture wire to power supply white wire with wire connector supplied; connect black fixture wire to power supply black wire with wire connector supplied.
Note: This fixture is wired using two conductor lamp cord. The insulation between the two conductors on the lamp cord can be split down the center for better access to the two conductors. The common wire on the lamp cord is identified as the conductor with ribs embossed in the rubber wire insulation.
3. Raise Canopy (3) to Wall, verify all wires are securely inside Canopy (3), then secure Canopy (3) in place by tightening Mounting screws (4) with the help of phillips screw driver (Not Provided) (5).
4. Screw on the light bulb and fixture is ready to use.